



ENGINEERED LIQUID LEVEL SOLUTIONS



DURABILITY AND DEPENDABILITY

FLAT GLASS GAUGES & VALVES FOR PROCESS LEVEL MEASUREMENT BY KENCO

FLAT GLASS GAUGES

KENCO Flat Glass Gauges are used where direct visual observation of process fluids is required. These gauges are suitable for a wide range of applications with pressures up to 4000psig @ 100°F, and temperatures up to @750 F to 2050 psig. KENCO gauges are available in either carbon steel or 316 stainless steel construction materials to meet most specifications. Other materials available upon request. Consult factory for details.

There are five main components common to all flat glass gauges:

- 1 CHAMBER**
Center of the gauge, and is the part that primarily contains the process fluid. It is machined from bar stock. The gasket seat is recessed for lateral support, and easy positioning.
- 2 COVER**
Protects the glass, and provides the compression surface for sealing the gauge. The cushion seat is a machined pocket for lateral support and easy positioning.
- 3 GLASS**
Provides the visual interface between the process fluid and the outside.
- 4 GASKET/CUSHION**
Provides for a seal between the chamber and glass (gasket), and protects the glass from mechanical stresses from the cover (cushion). For a given gauge, the gasket and cushion are normally the same material.
- 5 BOLTS/STUDS/NUTS**
Provides a uniform compression load to the gauge for pressure sealing.

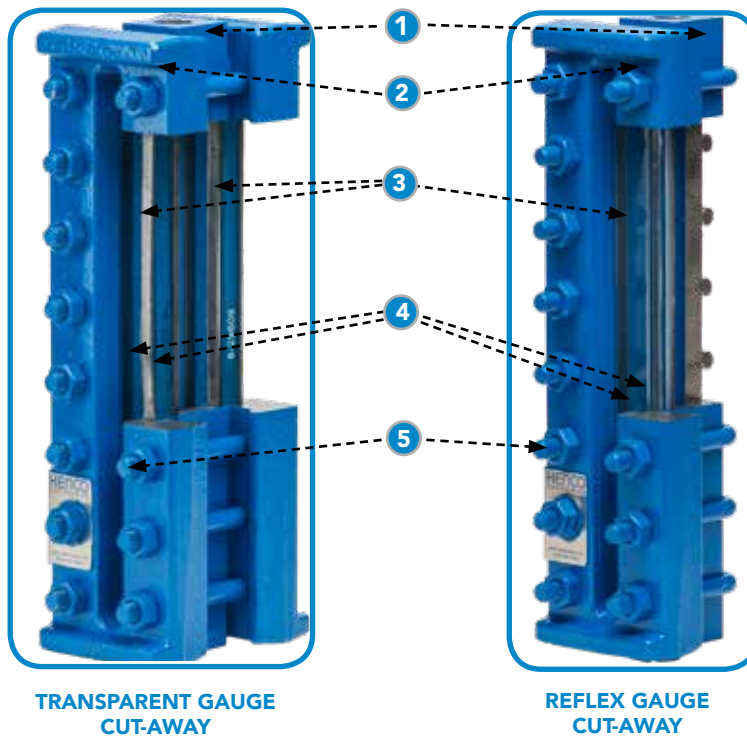

REFLEX & TRANSPARENT STYLES

Reflex gauges have a single piece of glass, mounted on one side of the chamber. This piece of glass is flat on the outside, and has a series of prisms on the inside, facing the process fluid. When light strikes the portion of the glass covered by a liquid, the light is reflected from the back of the chamber. This area appears "black". When light strikes the glass where no liquid is present, the prisms reflect the light directly out of the gauge. This area appears "silvery". Reflex gauges provide an excellent way to measure clear, or difficult to see fluids. The "silvery" / "black" interface is easy to see from several feet away.

Transparent gauges have two pieces of glass on opposite sides of the chamber. Light enters the gauge from one side, and the level is viewed from the other. Transparent gauges are useful when the actual liquid characteristics need to be seen. They are also commonly used for liquid-liquid interfaces. Mica shields can be used in transparent gauges to protect the glass in steam environments. Kel-F shields should be used in corrosive environments.

WHY USE FLAT GLASS GAUGES

Flat Glass Gauges have been in use for over 100 years. They give you the ability to directly view the process fluid under temperature/pressure conditions that would render most other level technologies useless. Their construction is very robust, and reliable. They define the term "simple to use". . .after installation, the only tool you will need is your eyes. Flat Glass Gauges are relatively inexpensive as compared to most other level technologies.

Other features:

- They do not need electrical power to operate. This can be a great advantage in the case of a power outage.
- Simple to install. . .no calibration is necessary.
- Can be used as a reference to check, or calibrate, other level technologies.
- Pressure rating from vacuum to 4000 psig.
- Temperature rating from -50°F–750°F (Carbon Steel) / -150°F–750°F 316 (Stainless Steel)
- Not affected by the chemical or electrical properties of the process liquid. Specific gravity, dielectric, conductivity, surface turbulence, vapor, foam, etc. no longer needs to be considered.

FLAT GLASS GAUGES vs. TUBULAR GLASS GAUGES

KENCO offers a wide range of Flat Glass and Tubular Glass Gauges. With all of those choices, one of the basic questions is: Should I use Flat Glass or Tubular Glass Gauges? The answer is fairly simple. If the process pressure is under 500psig and the process temperature is under 400°F, tubular style gauges should be considered. KENCO tubular gauges shield the glass on all four sides to virtually eliminate glass breakage, and tubular gauges are even more cost effective than flat glass gauges. Regardless of the style chosen, KENCO's high quality gauges will provide you with many years of reliable service.

MEDIUM PRESSURE FLAT GLASS GAUGES



KENCO Medium Pressure Flat Glass Gauges are versatile enough for most common process conditions. Standard carbon steel gauges meet the requirements of NACE MR0175. Unlike other manufacturers, there is no additional charge for NACE.

All materials meet or exceed ASTM specifications. Model KMR Reflex Gauges can reach process pressures up to 3000psig. Model KMT Transparent Gauges can handle pressures up to 2000psig. See the Ratings' tables below for specific information about a particular gauge size.

While these gauges are not specifically designed for steam service, the Model KMR gauges will perform at saturated steam pressures up to 300WSP. The Model KMT will perform at saturated steam pressures up to 450WSP, depending upon gauge size. Mica shields are required for model KMT when used in steam applications above 300 WSP. Shields cannot be used with Reflex Gauges.

REFLEX GAUGE (MODEL KMR)

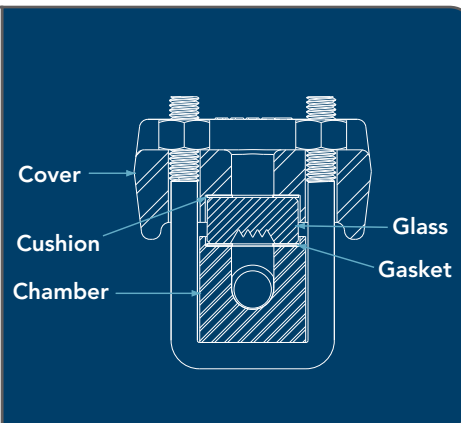
Pressure / Temperature Ratings									
GLASS SIZE									
°F	1	2	3	4	5	6	7	8	9
100	3000	2875	2750	2625	2500	2375	2250	2125	2000
200	2735	2620	2505	2395	2280	2165	2050	1940	1825
300	2660	2550	2440	2325	2215	2105	1995	1885	1775
400*	2565	2460	2355	2245	2140	2035	1925	1820	1715
500*	2425	2325	2225	2120	2020	1920	1820	1720	1620
600*	2215	2125	2030	1940	1845	1755	1660	1570	1480
SATURATED STEAM RATING: 300 WSP									

*Temperatures above 470° F require Aluminosilicate glass. Aluminosilicate glass is not recommended for steam applications



TRANSPARENT GAUGE (MODEL KMT)

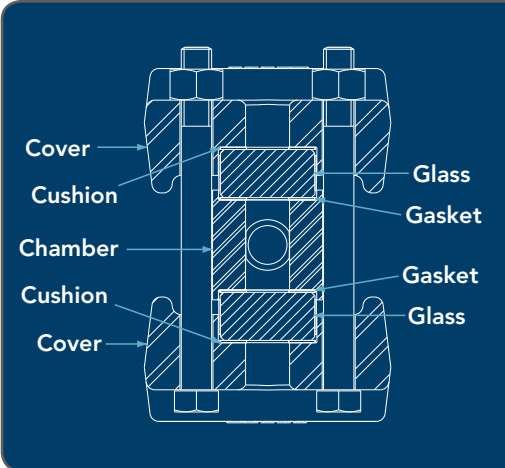

Pressure / Temperature Ratings									
GLASS SIZE									
°F	1	2	3	4	5	6	7	8	9
100	2000	1875	1750	1625	1500	1375	1250	1125	1000
200	1825	1710	1595	1480	1370	1255	1140	1025	910
300	1775	1665	1555	1445	1335	1220	1110	995	885
400	1715	1610	1500	1395	1285	1180	1070	960	855
500*	1620	1520	1415	1315	1215	1115	1010	910	810
600*	1480	1385	1295	1200	1110	1015	925	830	735
SATURATED STEAM USING MICA SHIELDS									
	450	450	450	450	450	450	450	400	350

*Mica shields must be used in KMT gauges with Borosilicate glass at temperatures above 570°F.

HIGH PRESSURE FLAT GLASS GAUGES

KENCO High Pressure Flat Glass Gauges have a superior rugged design for the most demanding process conditions. Standard carbon steel gauges meet the requirements of NACE MR0175. Unlike other manufacturers, there is no additional charge for NACE.

All materials meet or exceed ASTM specifications. Model KHR Reflex Gauges can reach process pressures up to 4000psig. Model KHT Transparent Gauges can handle pressures up to 3000psig. See the Ratings' tables below for specific information about a particular gauge size.

While these gauges are not specifically designed for steam service, the Model KHR gauges will perform at saturated steam pressures up to 300WSP. The Model KHT will perform at saturated steam pressures up to 450WSP. Mica shields are required for Model KHT when used in steam applications above 300WSP. Shields cannot be used with Reflex Gauges.

REFLEX GAUGE (MODEL KHR)

Pressure / Temperature Ratings									
°F	GLASS SIZE								
	1	2	3	4	5	6	7	8	9
100	4000	4000	4000	4000	4000	4000	4000	4000	4000
200	3675	3675	3675	3675	3675	3675	3675	3675	3675
300	3350	3350	3350	3350	3350	3350	3350	3350	3350
400*	3025	3025	3025	3025	3025	3025	3025	3025	3025
500*	2800	2800	2800	2800	2800	2800	2800	2800	2800
600*	2500	2500	2500	2500	2500	2500	2500	2500	2500
750*	2050	2050	2050	2050	2050	2050	2050	2050	2050
SATURATED STEAM RATING: 300 WSP									

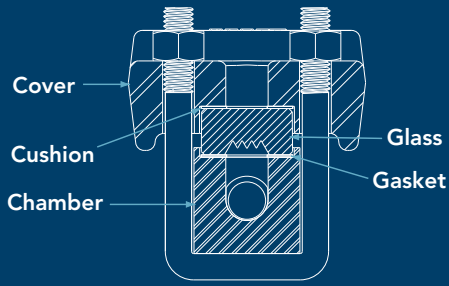

*Temperatures above 470° F require Aluminosilicate glass. Aluminosilicate glass is not recommended for steam applications.

TRANSPARENT GAUGE (MODEL KHT)



Pressure / Temperature Ratings									
°F	GLASS SIZE								
	1	2	3	4	5	6	7	8	9
100	3000	3000	3000	3000	3000	3000	3000	3000	3000
200	2920	2920	2920	2920	2920	2920	2920	2920	2920
300	2850	2850	2850	2850	2850	2850	2850	2850	2850
400	2780	2780	2780	2780	2780	2780	2780	2780	2780
500*	2600	2600	2600	2600	2600	2600	2600	2600	2600
600*	2310	2310	2310	2310	2310	2310	2310	2310	2310
750*	1700	1700	1700	1700	1700	1700	1700	1700	1700
SATURATED STEAM USING MICA SHIELDS									
	450	450	450	450	450	450	450	450	450

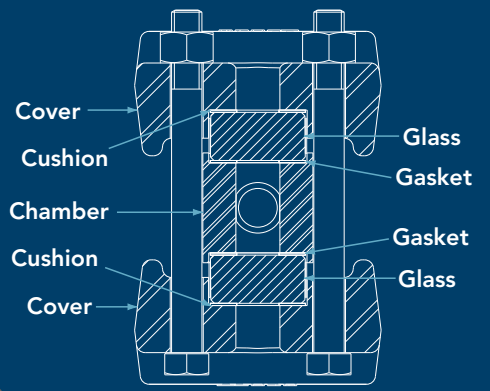

* Temperatures above 570° F require Aluminosilicate glass.
 ** Do not exceed 680° F with Mica shields.

GAUGE INFORMATION

GAUGE LENGTHS (Inches)

# OF GAUGE SECTIONS	NUMBER OF SECTIONS / GLASS SIZE DESIGNATOR	VISIBLE LENGTH	OVERALL LENGTH OF END CONNECTED GAUGES	MINIMUM SIDE CONNECTED GAUGE C-C LENGTH (NO VALVES)		# OF GAUGE SECTIONS	NUMBER OF SECTIONS / GLASS SIZE DESIGNATOR	VISIBLE LENGTH	OVERALL LENGTH OF END CONNECTED GAUGES	MINIMUM SIDE CONNECTED GAUGE C-C LENGTH (NO VALVES)	
				1/2" NPT	3/4" NPT					1/2" NPT	3/4" NPT
1	11	3.750	5.250	5.250	5.625	3	36	30.375	31.875	31.875	32.250
	12	4.750	6.250	6.250	6.625		37	33.750	35.250	35.250	35.625
	13	5.750	7.250	7.250	7.625		38	38.625	40.125	40.125	40.500
	14	6.750	8.250	8.250	8.625		39	40.875	42.375	42.375	42.750
	15	7.875	9.375	9.375	9.750	4	47	45.500	47.000	47.000	47.375
	16	9.125	10.625	10.625	11.000		48	52.000	53.500	53.500	53.875
	17	10.250	11.750	11.750	12.125		49	55.000	56.500	56.500	56.875
	18	11.875	13.375	13.375	13.750	5	57	57.250	58.750	58.750	59.125
	19	12.625	14.125	14.125	14.500		58	65.375	66.875	66.875	67.250
2	23	13.000	14.500	14.500	14.875	6	59	69.125	70.625	70.625	71.000
	24	15.000	16.500	16.500	16.875		68	78.750	80.250	80.250	80.625
	25	17.250	18.750	18.750	19.125	69	83.250	84.750	84.750	85.125	
	26	19.750	21.250	21.250	21.625	7	78	92.125	93.625	93.625	94.000
	27	22.000	23.500	23.500	23.875		79	97.375	98.875	98.875	99.250
	28	25.250	26.750	26.750	27.125	8	88	105.500	107.000	107.000	107.375
	29	26.750	28.250	28.250	28.625		89	111.500	113.000	113.000	113.375
						9	98	118.875	120.375	120.375	120.750
							99	125.625	127.125	127.125	127.500

MINIMUM C-C DIMENSIONS FOR END CONNECTED GAUGES WITH KMVR/KHVR VALVES (Inches)

Note: The minimum center to center dimensions in this chart are based on 1/2" FNPT gauge connections. To find the minimum center to center dimension with 3/4" FNPT gauge connections, add 1/2" to the minimum dimensions shown in the chart.

MODEL	MINIMUM C TO C	VISIBLE GLASS
KMR(T)/KHR(T)11	8-7/8	3-3/4
KMR(T)/KHR(T)12	9-7/8	4-3/4
KMR(T)/KHR(T)13	10-7/8	5-3/4
KMR(T)/KHR(T)14	11-7/8	6-3/4
KMR(T)/KHR(T)15	13	7-7/8
KMR(T)/KHR(T)16	14-1/4	9-1/8
KMR(T)/KHR(T)17	15-3/8	10-1/4
KMR(T)/KHR(T)18	17	11-7/8
KMR(T)/KHR(T)19	17-3/4	12-5/8
KMR(T)/KHR(T)23	18-1/8	13
KMR(T)/KHR(T)24	20-1/8	15
KMR(T)/KHR(T)25	22-3/8	17-1/4
KMR(T)/KHR(T)26	24-7/8	19-3/4
KMR(T)/KHR(T)27	27-1/8	22
KMR(T)/KHR(T)28	30-3/8	25-1/4
KMR(T)/KHR(T)29	31-7/8	26-3/4
KMR(T)/KHR(T)36	35-1/2	30-3/8
KMR(T)/KHR(T)37	38-7/8	33-3/4

MODEL	MINIMUM C TO C	VISIBLE GLASS
KMR(T)/KHR(T)38	43-3/4	38-5/8
KMR(T)/KHR(T)39	46	40-7/8
KMR(T)/KHR(T)47	50-5/8	45-1/2
KMR(T)/KHR(T)48	57-1/8	52
KMR(T)/KHR(T)49	60-1/8	55
KMR(T)/KHR(T)57	62-3/8	57-1/4
KMR(T)/KHR(T)58	70-1/2	65-3/8
KMR(T)/KHR(T)59	74-1/4	69-1/8
KMR(T)/KHR(T)68	83-7/8	78-3/4
KMR(T)/KHR(T)69	88-3/8	83-1/4
KMR(T)/KHR(T)78	97-1/4	92-1/8
KMR(T)/KHR(T)79	102-1/2	97-3/8
KMR(T)/KHR(T)88	110-5/8	105-1/2
KMR(T)/KHR(T)89	116-5/8	111-1/2
KMR(T)/KHR(T)98	124	118-7/8
KMR(T)/KHR(T)99	130-3/4	125-5/8

Consult factory for the minimum center to center of an End Connected Gauge when using KMVU/KHVU valves.

ORDERING GUIDE

Flat Glass Level Gauge

REQUESTED BY: _____ COMPANY: _____

ADDRESS: _____ CITY: _____ STATE: _____ ZIP: _____

PHONE: _____ FAX: _____ EMAIL: _____

Gauge Type	Gauge Style	Number of Gauge Sections		Glass Size	Material
KH = High Pressure	R = Reflex	1	6	1 thru 9 - 1 section	A = 316 S.S. W/O Shield
KM = Medium Pressure	T = Transparent	2	7	3 thru 9 - 2 sections	C = Carbon Steel W/O Shield
		3	8	6 thru 9 - 3 sections	W = 316 S.S. (Wetted) W/O Shield
		4	9	7 thru 9 - 4 sections	K = 316 S.S. W/ Mica Shield
		5		7 thru 9 - 5 sections	L = Carbon Steel W/ Mica Shield
				8 or 9 - 6 sections	M = 316 S.S. (Wetted) W/ Mica Shield
				8 or 9 - 7 sections	G = 316 S.S. W/ KEL-F Shield
				8 or 9 - 8 sections	H = Carbon Steel W/ KEL-F Shield
				8 or 9 - 9 sections	J = 316 S.S. (Wetted) W/ KEL-F Shield

Connection Location	Connection Size	Connection Type	Center to Center Gauge Distance
B = Back	50 = 1/2"	N = FNPT	(Leave blank for end connections)
E = End	75 = 3/4"	S = Socket Weld (Female)	(Three place decimal rounded to the nearest 1/32")
L = Left	10 = 1" Flange Only	A = 150 LB. R.F. Flange	H = 300 LB. R.T.J. Flange
R = Right	15 = 1-1/2" Flange Only	B = 300 LB. R.F. Flange	J = 600 LB. R.T.J. Flange
	20 = 2" Flange Only	C = 600 LB. R.F. Flange	K = 900 LB. R.T.J. Flange
	30 = 3" Flange Only	D = 900 LB. R.F. Flange	L = 1500 LB. R.T.J. Flange
	40 = 4" Flange Only	E = 1500 LB. R.F. Flange	P = 2500 LB. R.T.J. Flange
	60 = 6" Flange Only	F = 2500 LB. R.F. Flange	
	80 = 8" Flange Only	G = 150 LB. R.T.J. Flange	

GAUGE CONSTRUCTION MATERIALS

Flat Glass Level Gauge

Part	Carbon Steel Construction Code "C" (Meets NACE MR0175)	SS Wetted Construction Code "W"	SS Construction Construction Code "A"	Optional Materials Construction Code "S"
Cover	ASTM A350 LF2 Carbon Steel	ASTM A350 LF2 Carbon Steel	316/316L SS	Consult Factory
Chamber	ASTM A350 LF2 Carbon Steel	316/316L SS	316/316L SS	Duplex SS; Alloy 20; Hastelloy-C
Glass	Borosilicate	Borosilicate	Borosilicate	Aluminosilicate
Gasket	Graphoil w/316 SS Insert	Graphoil w/316 SS Insert	Graphoil w/316 SS Insert	Non-Asbestos; Teflon® (25% Glass Filled)
Cushion	Graphoil w/316 SS Insert	Graphoil w/316 SS Insert	Graphoil w/316 SS Insert	Non-Asbestos; Teflon® (25% Glass Filled)
U-Bolt/Stud	ASTM A193 B7	ASTM A193 B7	ASTM A193/320 B8M CL2	Consult Factory
Nut	ASTM A194 2H	ASTM A194 2H	ASTM A194 8M	Consult Factory

GAUGE ILLUMINATORS

To improve the visibility of fluid contained in a KENCO Transparent Level Gauge, a specially sized illuminator can be used. The illumination is provided by extra bright Green LED's (Light Emitting Diodes). This light is brighter than ordinary incandescent light bulbs, consume less power, and can last 200 times longer, with an estimated life of 100,000 hours. The Illuminator mounts directly onto the transparent gauge without the need for loosening the bolts on the gauge. The power supply is contained inside a NEMA 4X enclosure. The unit is 115Vac/230Vac powered and draws less than 150mA of current.

The Model KLI Illuminator is UL Listed and CSA Certified for Class I, Division 1, Group B, C & D defined hazardous areas.

Model Configuration

KLI - □ - □ - □

Size (See Table Below) _____

Power Supply _____

Options _____

Input Power

Description	Code
115Vac	115AC
230Vac	230AC

Options

Description	Code
None	0
Remote P.S.	1

Provide Cable length for Option #1

MODEL	Overall Length "A"	
	Inches	mm
KLI-15	10.8	274
KLI-16	12.1	306
KLI-17	13.2	335
KLI-18	14.8	376
KLI-19	15.6	395
KLI-23	15.9	405
KLI-24	17.9	455
KLI-25	20.2	513
KLI-26	22.7	576
KLI-27	24.9	633
KLI-28	28.2	716
KLI-29	29.7	754
KLI-36	33.3	846
KLI-37	36.7	932
KLI-38	41.6	1055
KLI-39	43.8	1113
KLI-47	48.4	1230
KLI-48	54.9	1395
KLI-49	57.9	1471



Technical Specifications

Power Supply..... 115/230Vac @ 50/60 HZ	Ambient Temperature..... -40°F (-40°C) to 150°F (65°C)
Power Consumption..... <150 mA @ 115Vac	LED Estimated Life..... 100,000 hours
Supply Connection..... 3/4 NPT	Certification..... UL1203, UL913, CSA 22.2 CL I, DIV 1, Groups B, C, & D NEMA 4X & 8

OTHER GAUGE ACCESSORIES

FROST PROOF EXTENSION

The KENCO Frost-proof Extension is used in low temperature applications where frost has a tendency to build up on the gauge. This extension prevents frost from covering the window, maintaining visibility at all times.

The Frost-proof Extension consists of a clear, plastic block that is in direct contact with the glass, and extends beyond the cover so that frost build-up does not block the glass.

Mounting is easy, and can be added to any Reflex or Transparent gauge in the field. The extension can be installed or removed for cleaning while the gauge is in service.



FROST-PROOF EXTENSION

GAUGE GLASS OPTIONS

KENCO supplies tempered borosilicate glass as standard in all Flat Glass Gauges. Borosilicate glass is suitable for most chemicals, and is good for temperatures up to 470°F for Reflex glass and 570°F for transparent glass. The tempering process improves the thermal shock resistance of the glass.

Aluminosilicate glass is offered as an option in Transparent gauges for higher temperature applications. It offers less thermal expansion, as compared to borosilicate glass. Aluminosilicate glass is good for temperatures up to 750°F. However, due to the added cost, it is only recommended for temperatures between 470°F to 750°F.

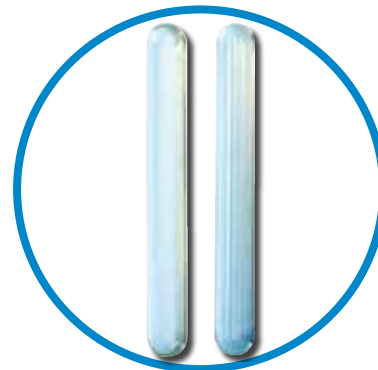

BOROSILICATE GLASS

GLASS SHIELDS

For corrosive or steam applications, KENCO offers shields to extend the life of the glass in Transparent gauges. The shields are made from either PCTFE (Kel-F) or Mica. Mica shields are recommended for steam service. Kel-F shields should be used in corrosive fluid applications. The shield is placed on the process side of the glass. Since this would interfere with the optical effect of reflex glass, shields can only be used with transparent glass.



MICA GLASS SHIELDS

SCALE OPTIONS

Gauge scales can be supplied to provide a numerical reference to the level being measured. Contact KENCO for more information.

FLAT GLASS GAUGE VALVES (GAUGE COCKS)

KENCO Gauge Cocks are designed for use with KENCO Flat Glass Gauges, or gauges from any other manufacturer. All valves are "Offset Pattern" design. This provides for gauge connections that are offset 0.750" from the centerline of the vessel connections. This allows the gauge to be cleaned by removing vent/drain plugs from the valve. All materials meet or exceed ASTM specifications.

PRESSURE/TEMPERATURE RATINGS:

- Model KMVx Valves are rated to 2500psig @ 100°F; 1400psig @ 750°F.
- Model KHVx Valves are rated to 4000psig @ 100°F; 1500psig @ 750°F;
KHVx valves also carry a steam rating of 450 WSP.

Series KMV Valve Standard Features:

- Safety Shut-off Ballchecks (Horizontal)
- Integral Bonnet
- Gauge Connection
 - Model KMVR – Rigid
 - Model KMVU – Union
- Union Vessel Connection
- Integral Seat

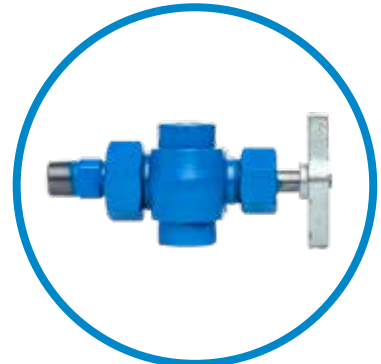

Series KHV Valve Standard Features:

- Safety Shut-off Ballchecks (Horizontal)
- Union Bonnet
- Gauge Connection
 - Model KHVR– Rigid
 - Model KHVU – Union
- Union Vessel Connection
- Threaded Renewable Seat

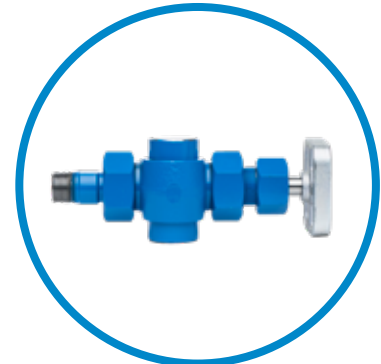

VALVE ORDERING GUIDE

Flat Glass Level Gauge

REQUESTED BY: _____ COMPANY: _____

ADDRESS: _____ CITY: _____ STATE: _____ ZIP: _____

PHONE: _____ FAX: _____ EMAIL : _____

Valve Type

KHV = High Pressure Valve
KMV = Medium Pressure Valve

Gauge Type

R = Rigid
U = Union

Material

A = 316 S.S.
C = Carbon Steel
W = 316 S.S. (Wetted)
N = Carbon Steel (Nace)
T = Carbon Steel (Low Temp)

Gauge Connection Size

50 = 1/2"
75 = 3/4"

Gauge Connection Type

N = FNPT
S = Socket Weld (Female)

Vessel Connection Size

50 = 1/2"
75 = 3/4"
10 = 1"
15 = 1-1/2"
20 = 2"
30 = 3"
40 = 4"
60 = 6"
80 = 8"

Vessel Connection Type

M = Union (MNPT)
N = Union (FNPT)
S = Socket Weld (Female)
A = 150 LB. R.F. flange
B = 300 LB. R.F. flange
C = 600 LB. R.F. flange
D = 900 LB. R.F. flange
E = 1500 LB. R.F. flange
F = 2500 LB. R.F. flange
G = 150 LB. R.T.J. flange
H = 300 LB. R.T.J. flange
J = 600 LB. R.T.J. flange
K = 900 LB. R.T.J. flange
L = 1500 LB. R.T.J. flange
P = 2500 LB. R.T.J. flange

VALVE CONSTRUCTION MATERIALS

Flat Glass Level Gauge

Part	Carbon Steel Construction Code "C" (Standard Construction)	Carbon Steel Construction Code "N" (Meets NACE MR0175)	Low Temperature (-50° F) Carbon Steel Construction Code "T"	SS Wetted Construction Code "W"	SS Construction Code "A"
Valve Body (Wetted)	ASTM A350 LF2 Carbon Steel	ASTM A350 LF2 Carbon Steel	ASTM A350 LF2 Carbon Steel	ASTM A182 316 SS	ASTM A182 316 SS
Valve Stem (Wetted)	416 HT SS	N50 SS	416 HT SS	316 SS	316 SS
Union Bonnet (KHVx only) (Wetted)	1018 Carbon Steel	ASTM A350 LF2 Carbon Steel	ASTM A350 LF2 Carbon Steel	316 SS	316 SS
Renewable Seat (KHVx only) (Wetted)	316 SS	N50 SS	316 SS	316 SS	316 SS
Gauge/Vessel Connections (Wetted)	1018 Carbon Steel	ASTM A350 LF2 Carbon Steel	ASTM A350 LF2 Carbon Steel	316 SS	316 SS
Packing Gland (Wetted)	SS-316N2-33 316SS (Sintered)	SS-316N2-33 316SS (Sintered)	SS-316N2-33 316SS (Sintered)	SS-316N2-33 316SS (Sintered)	SS-316N2-33 316SS (Sintered)
Packing (Wetted)	Flexible Graphite	Flexible Graphite	Flexible Graphite	Flexible Graphite	Flexible Graphite
Check Ball (Wetted)	316 SS	316 SS	316 SS	316 SS	316 SS
Union/Packing Nuts (Non-Wetted)	1018 Carbon Steel	1018 Carbon Steel	316 SS	1018 Carbon Steel	316 SS
Handle (Non-Wetted)	ASTM A216 Carbon Steel	ASTM A216 Carbon Steel	ASTM A351 316 SS	ASTM A216 Carbon Steel	ASTM A351 316 SS

MAXIMUM GAUGE LENGTH POSSIBLE FOR A KNOWN VESSEL CENTER-TO-CENTER (C-C):

End Connected Gauges

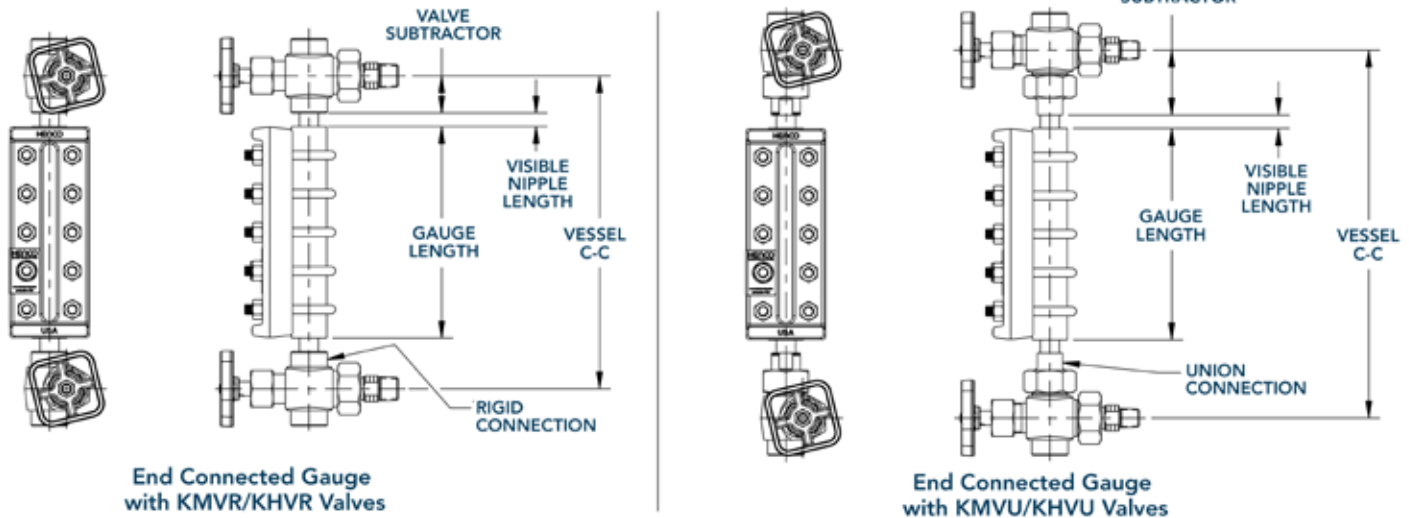

$$\text{Max. End Connected Gauge Length} = \left(\text{Vessel C-C Dimension} \right) - (2 \times (\text{Valve Subtractor} + \text{Visible Nipple Length}))$$

Instructions to determine the Maximum End Connected Gauge Length for known Vessel C-C:

1. Insert the desired Vessel C-C Length, Valve Subtractor and Minimum Visible Nipple Length into the Maximum End Connected Gauge Length formula above.
2. The proper Gauge Size will be the closest End Connected Overall Gauge Length from the Gauge Lengths chart on page 5 that is less than or equal to the number derived from the formula above.

Example: The Maximum End Connected Overall Gauge Length for a Kenco KMR Medium Pressure Reflex Gauge with 1/2"-14 NPT End Connections, KMVR Medium Pressure Rigid Valves and a Vessel C-C Length of 13.875" is calculated as follows: $13.875" - (2 \times (1.65" + 0.16")) = 10.255"$. The longest End Connected Gauge Size from the Gauge Lengths chart on page 5 that is less than or equal to 10.255" is a Gauge Size 15 with an overall length of 9.375". In this case, Gauge Size 15 would be the longest Gauge that can be used in this application.

VALVE SUBTRACTORS	
KMVR/KHVR VALVES	1.65"
KMVU/KHVV VALVES	2.88"

MINIMUM VISIBLE NIPPLE LENGTHS	
1/2"-14 NPT GAUGE CONNECTIONS	0.16"
3/4"-14 NPT GAUGE CONNECTIONS	0.41"

Side/Back Connected Gauges

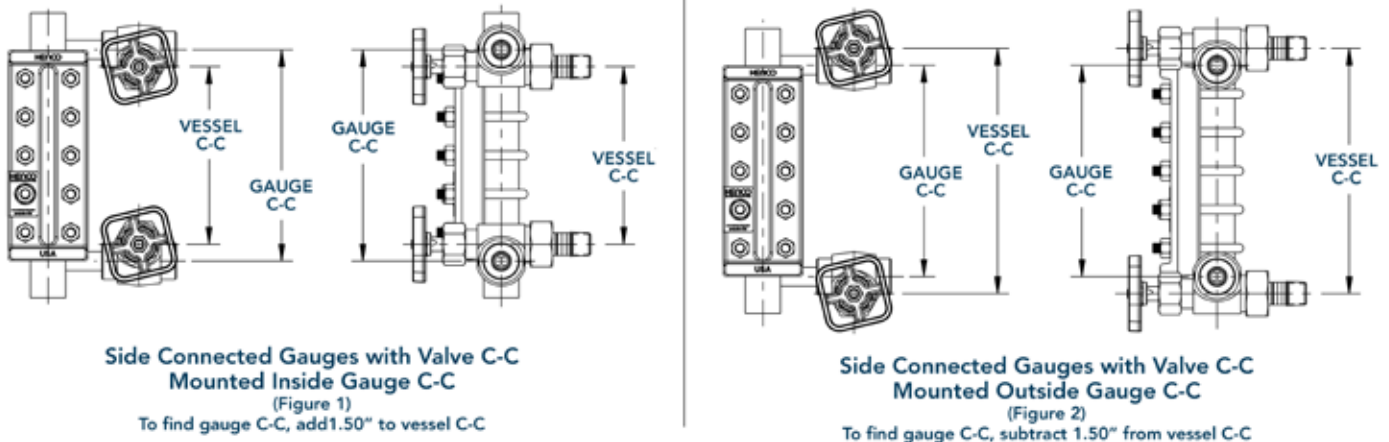

Instructions to determine the Minimum Side Connected Gauge C-C Length for known Vessel C-C:

1. Determine which valve orientation is best for your application.

Note: Figures 1 and 2 above illustrate the two valve orientations to consider when determining the proper Gauge Size for your Vessel C-C. The Valve Vessel Connections are offset from the Valve Gauge Connections and can be installed with the Gauge Connections to the outside as shown in Figure 1 or to the inside as shown in Figure 2. Mounting the Valves with the Gauge Connections to the outside as shown in Figure 1 provides the most Gauge Visible Length possible.

2. Figure 1 Gauge Size is determined by adding 1-1/2" to the Vessel C-C Length and comparing that value to the Minimum Side Connected Gauge C-C Length column on the Gauge Lengths chart on page 5. The proper Gauge Size will be the closest Minimum Side Connected Gauge C-C Length that is less than or equal to the calculated value.

Example: The Minimum Side Connected Gauge C-C Length for a Kenco KMR Medium Pressure Reflex Gauge with 1/2"-14 NPT Gauge Connections, KMVR Medium Pressure Rigid Valves and a Vessel C-C Length of 13.875" is calculated as follows: $13.875" + 1.500" = 15.375"$. The closest Minimum Side Connected Gauge C-C Length from the Gauge Lengths chart on page 5 that is less than or equal to 15.375" is 14.500", which is equivalent to a Gauge Size 23. In this case, a Gauge Size 23 would be manufactured with a Gauge C-C length of 15.375".

3. Figure 2 Gauge Size is determined by subtracting 1-1/2" from the Vessel C-C Length and comparing that value to the Minimum Side Connected Gauge C-C Length column on the Gauge Lengths chart on page 5. The Proper Gauge Size will be the closest Minimum Side Connected Gauge C-C Length that is less than or equal to the calculated value.

Example: The Minimum Side Connected Gauge C-C Length for a Kenco KMR Medium Pressure Reflex Gauge with 1/2"-14 NPT Gauge Connections, KMVR Medium Pressure Rigid Valves and a Vessel C-C Length of 13.875" is calculated as follows: $13.875" - 1.500" = 12.375"$. The closest Minimum Side Connected Gauge C-C Length from the Gauge Lengths chart on page 5 that is less than or equal to 12.375" is 11.750", which is equivalent to a Gauge Size of 17. In this case, a Gauge Size 17 would be manufactured with a Gauge C-C Length of 12.375".

APPLICATION DATA SHEET

FLAT GLASS GAUGE

Pressure rating: Medium Pressure High Pressure

Gauge Style: Reflex Transparent

No. of Gauge Sections: 1 2 3 4 5 6 7 8 9

Gauge Glass Size: 1 2 3 4 5 6 7 8 9

Gauge Material: Carbon Steel (Meets Nace; Low Temp Rating to -50° F) 316 SS Wetted 316 SS

Glass Shield: No Shield Mica Shield (Transparent gauge only) Kel-F Shield (Transparent gauge only)

Connection Location: End Side (Right) Side (Left) Back

Connection Size: 1/2" 3/4" 1" 1-1/2" 2" 3" 4" 6" 8"
(Note: 1" through 8" sizes available as flanged connections only)

Connection Type: NPT (Female) Socket Weld (Female) Flange

Connection Flange Type (if applicable): Threaded Raised Face Threaded R.T.J.

Connection Flange Size (if applicable): 150 LB 300 LB 600 LB 900 LB 1500 LB 2500 LB

Center to Center Connection Length (Side/back connect only): _____ Inches Millimeters

Design Pressure Rating: _____ psig @ _____ °F

Consult Factory for other requirements if needed.

FLAT GLASS GAUGE VALVES

Assemble Valves to Gauge: Yes No

Assembled Vessel Center to Center Distance (If assembling valves to gauge): _____ Inches Millimeters

Pressure Rating: Medium Pressure (2500 psi @ 100°F) High Pressure (4000 psi @ 100° F)

Material: Carbon Steel Low Temp Carbon Steel (-50° F) Nace Carbon Steel 316 SS Wetted 316 SS

Gauge Connection Style: Rigid Connection Union Connection

Gauge Connection Size: 1/2" 3/4"

Gauge Connection Type: NPT (Female) Socket Weld (Female)

Vessel Connection Size: 1/2" 3/4" 1" 1-1/2" 2" 3" 4" 6" 8"
(Note: 1" through 8" sizes available as flanged connections only)

Vessel Connection Type: NPT (Male Union) NPT (Female Union) Socket Weld (Female) Flange

Vessel Connection Flange Type (If applicable): Threaded Raised Face Threaded R.T.J.

Vessel Connection Flange Size (If applicable): 150 LB 300 LB 600 LB 900 LB 1500 LB 2500 LB

Consult factory for other requirements if needed

Represented by:

Kenco Sales Offices:

Headquarters

10001 E. 54th St.
Tulsa, OK 74146
phone 918.663.4406
fax 918.663.4480
www.kenco-eng.com
email: info@kenco-eng.com

Baton Rouge Office

11616 Industriplex, Suite 7
Baton Rouge, LA 70809
phone 225.755.1912
fax 225.755.1913
www.kenco-eng.com
email: kenco-la@kenco-eng.com

75301 (11-13-18)

